

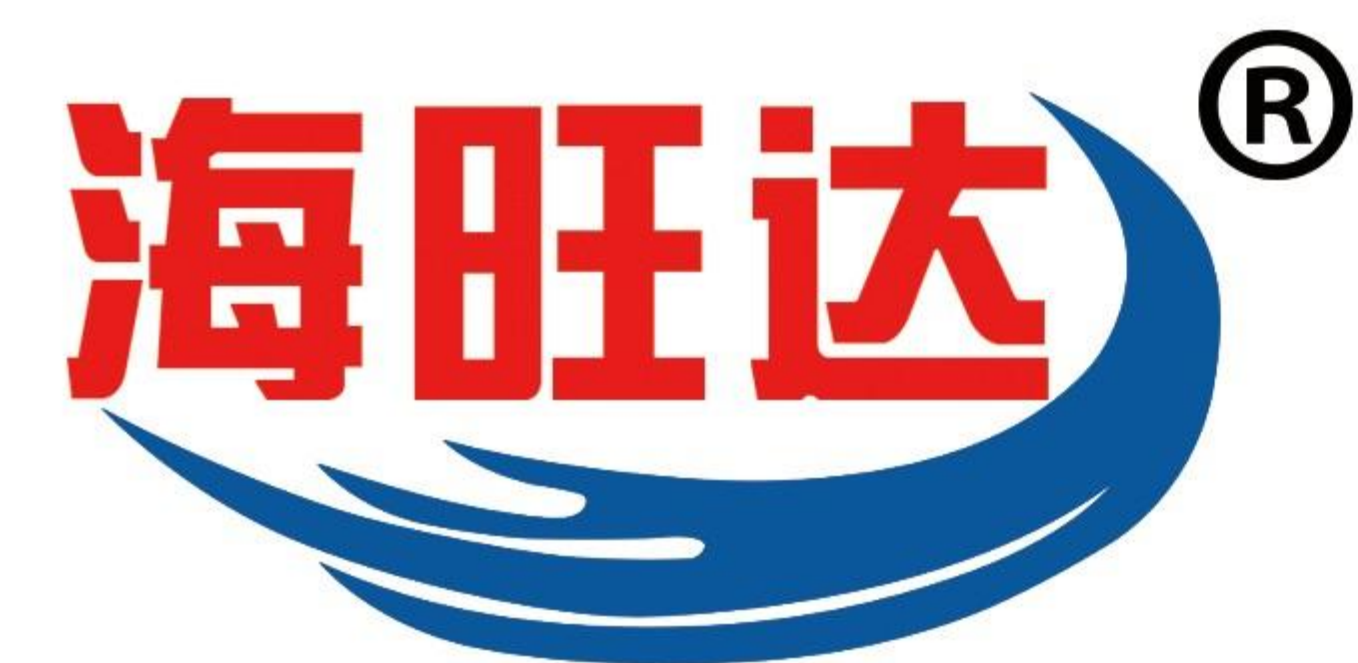

-- SPECIAL CONTAINER --



-- SPECIAL CONTAINER --



**HAIWANGDA  
SPECIAL  
CONTAINER**

**特种集装箱**

网址: [www.haiwangda.com](http://www.haiwangda.com)

电话: 15373330088 15118856888

地址: 河北省沧州市新华区交通北大道100号 (总厂)

广东省江门市台山市水步镇文华开发区A区2号-1B幢厂房 (分厂)

沧州海旺达特种集装箱制造有限公司  
Cangzhou Haiwangda Special Container Manufacturing Co., Ltd.

沧州海旺达特种集装箱制造有限公司  
Cangzhou Haiwangda Special Container Manufacturing Co., Ltd.



# 目录

## Table of Contents

01	公司简介——01	09	军用箱——15
02	发展历程——03	10	防爆箱——17
03	企业资质——05	11	近海箱——19
04	发明专利——07	12	工具箱——23
05	完善的生产设备——09	13	热能箱——24
06	团队实力——11	14	集装箱式加气站——25
07	技术支持——12	15	集装箱模块化消防站——27
08	环保箱——13	16	集装箱配件——29
		17	合作伙伴——31





深耕行业 稳步发展

诚信立业 匠心筑品



## Company profile 公司简介

沧州海旺达特种集装箱制造有限公司(总部)坐落于河北沧州，现依托总部成熟完善的制造与管理体系，公司特设立广东分公司并已正式运营，分公司位于广东省江门市。历经二十余年的拼搏发展，公司已成为规模化、体系化的高新技术特种集装箱制造企业，拥有自主对外贸易进出口权。现有两座现代化厂区，总占地面积10万平方米，配套标准集装箱试验平台。

公司主营各类特种集装箱与标准集装箱的设计、研发与制造，年产能达3000余台，年产值超亿元。产品畅销全国，并出口东南亚、中东、南美等多个国家和地区，是中石油、中石化、中海油、国家电网等大型央企的定点集装箱生产厂家，连续多年获评市级“重合同、守信用”企业。先后通过ISO9001:2015质量管理体系、ISO14001:2015环境管理体系、ISO45001:2018职业健康安全管理体系、中国船级社工厂认证、GJB9001C-2017武器装备质量管理体系等多项权威认证，累计拥有十余项集装箱实用新型专利技术。

企业始终坚持以客户为中心，深耕技术创新、弘扬工匠精神、精益求精、品质至上。期待与社会各界朋友精诚合作、优势互补、协同发展、同创辉煌!

Cangzhou Haiwangda Special Container Manufacturing Co., Ltd. (Headquarters) is located in Cangzhou, Hebei Province. Leveraging the mature and well-established manufacturing and management systems of the headquarters, the company has established a branch in Guangdong, which is now officially operational. The branch is situated in Jiangmen City, Guangdong Province. After more than two decades of dedicated development, the company has grown into a large-scale, systematic high-tech special container manufacturing enterprise with independent foreign trade import and export rights. It currently operates two modern production facilities, covering a total area of 100,000 square meters, and is equipped with a standard container testing platform.

The company specializes in the design, research and development, and manufacturing of various types of special and standard containers, with an annual production capacity of over 3000 units and an annual output value exceeding 100 million yuan. Our products are sold well throughout the country and exported to multiple countries and regions such as Southeast Asia, the Middle East, and South America. We are a designated container manufacturer for large central enterprises such as PetroChina, Sinopec, CNOOC, and State Grid, and have been awarded the title of "Contract abiding and Creditworthy" enterprise at the municipal level for several consecutive years. We have successively passed multiple authoritative certifications such as ISO9001:2015 Quality Management System, ISO14001:2015 Environmental Management System, ISO45001:2018 Occupational Health and Safety Management System, China Classification Society Factory Certification, GJB9001C-2017 Weapon and Equipment Quality Management System, and have accumulated more than ten new patented technologies for container use.

The enterprise always adheres to customer centricity, deeply cultivates technological innovation, promotes the spirit of craftsmanship, strives for excellence, and puts quality first. Looking forward to sincere cooperation, complementary advantages, collaborative development, and creating brilliance with friends from all walks of life in society!

Development History  
发展历程





Enterprise qualification  
**企业资质**

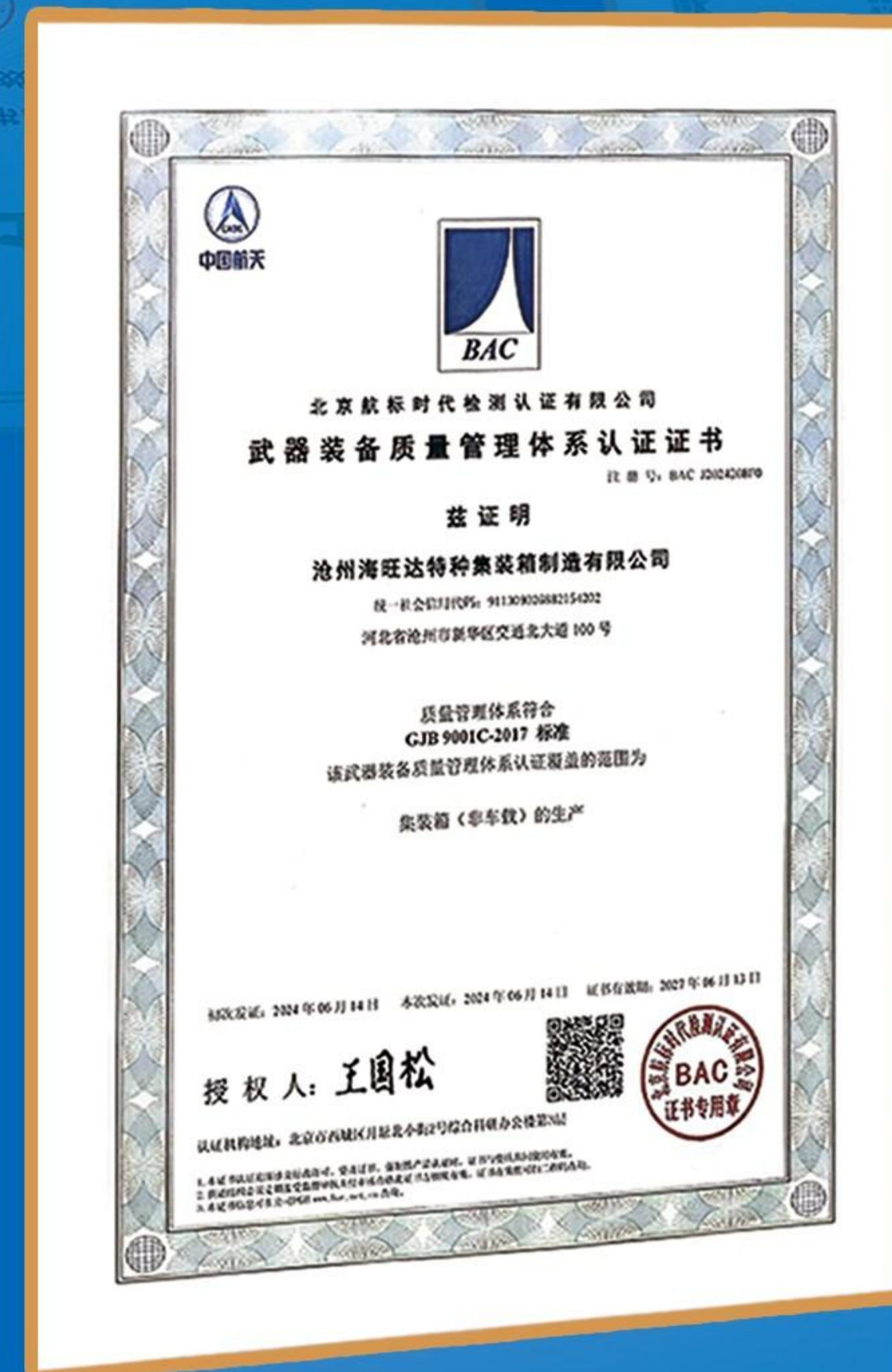
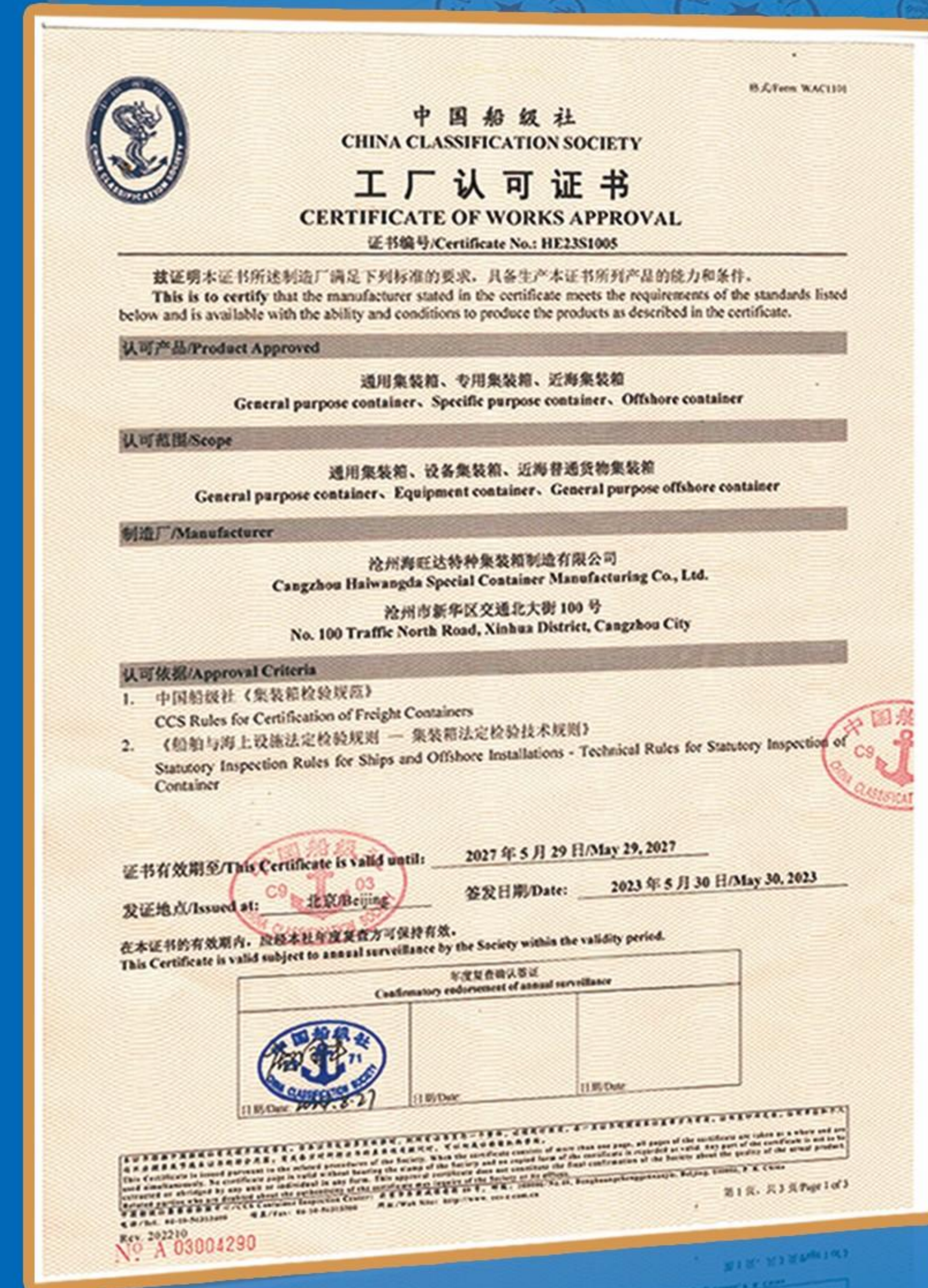
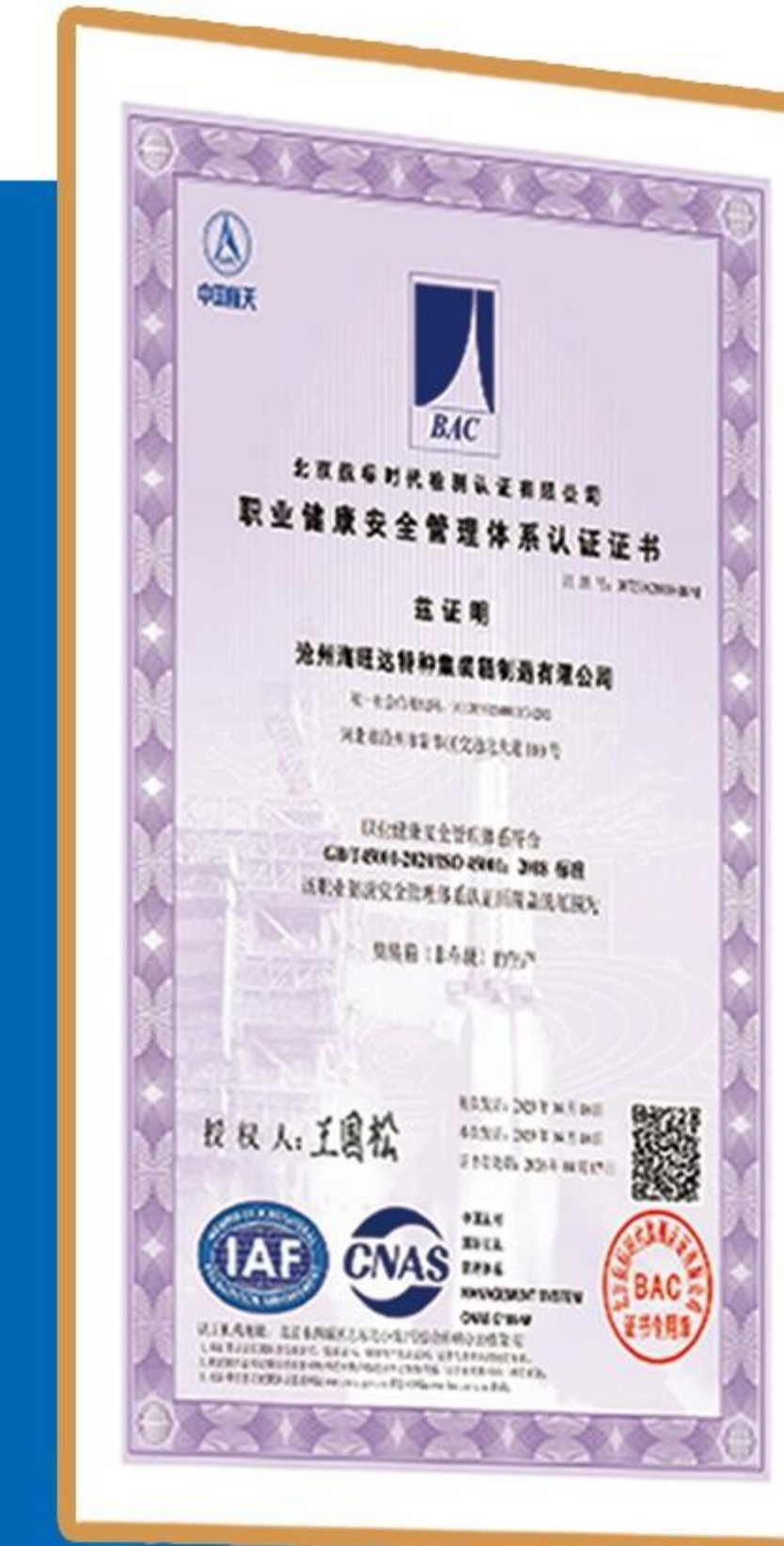

# Invention patent 发明专利



Well developed production equipment  
**完善的生产设备**



总厂车间



分厂车间

- 高新技术企业单位
- 配备先进的全套生产设备
- 工厂建筑面积达 10 万平方米
- 已顺利通过 ISO 三体系认证、中国船级社工厂认证
- 核心技术均为自主研发，累计拥有各类专利 10 余项

- High-tech enterprise unit
- Equipped with advanced complete production equipment
- The factory has a construction area of 100,000 square meters
- Successfully passed ISO three system certification and China Classification Society factory certification
- The core technologies are all independently developed, and we have accumulated more than 10 patents of various types

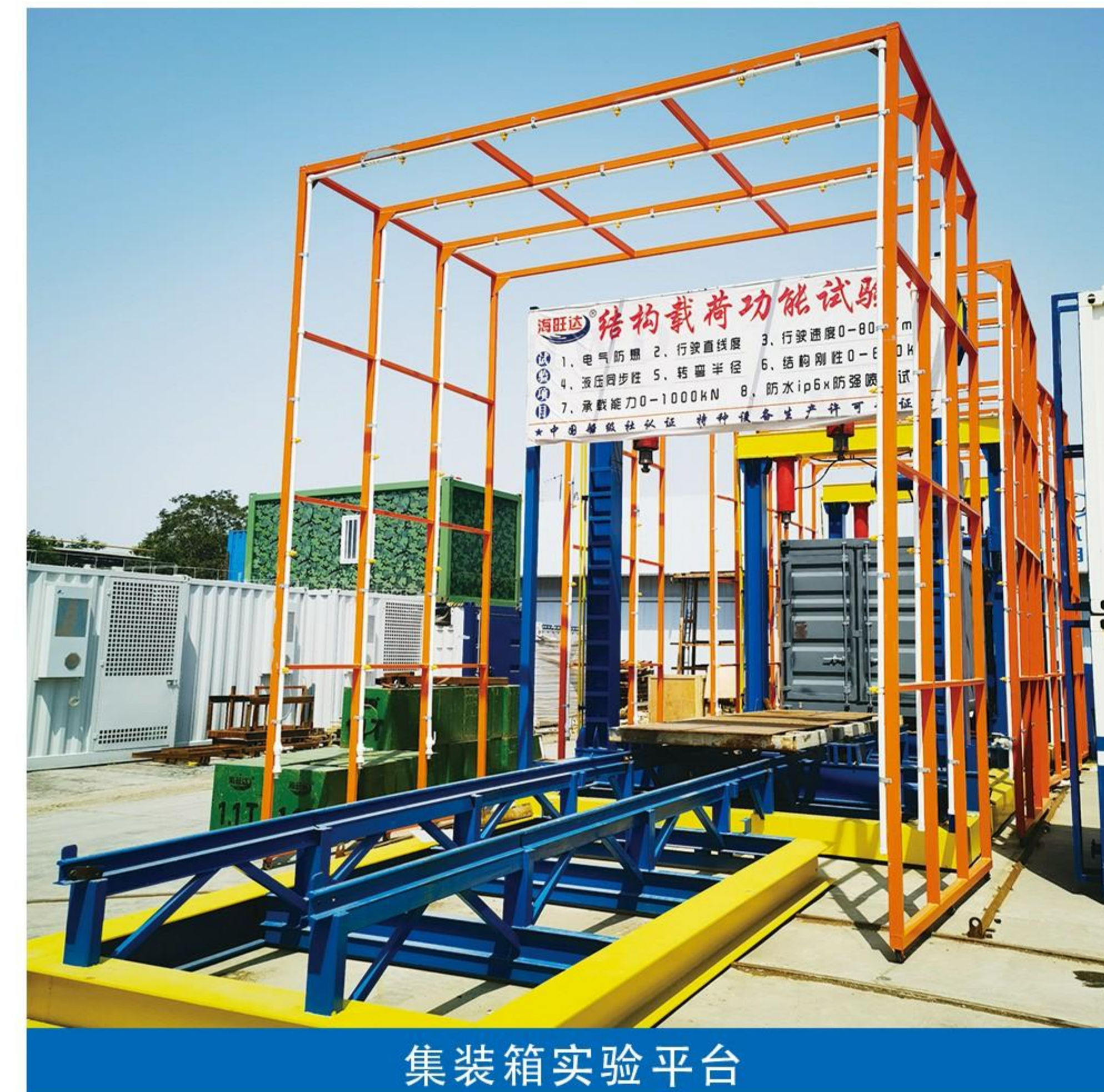

集装箱实验平台



厂区一角



喷漆房



打砂房

# Team strength 团队实力

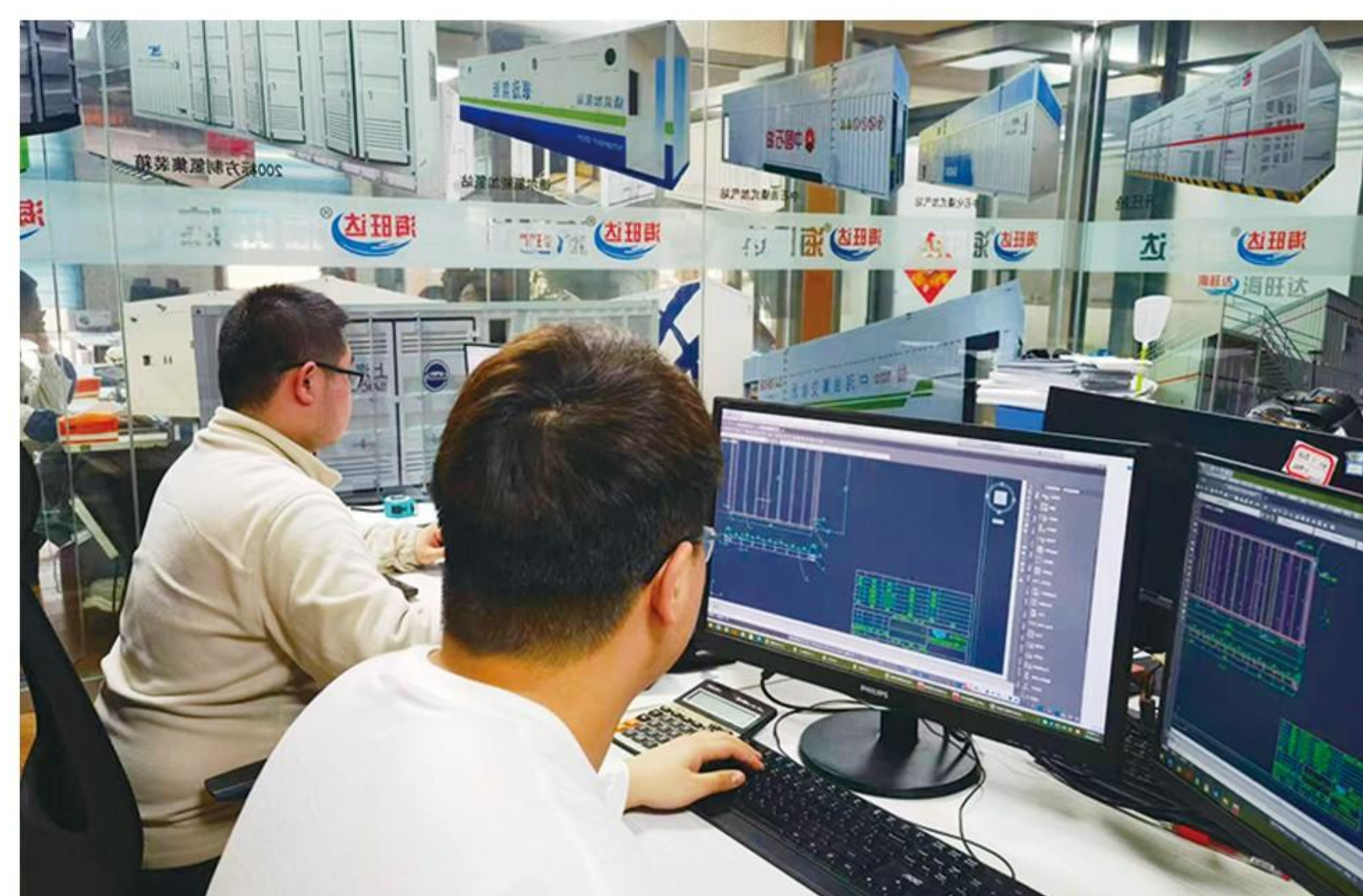
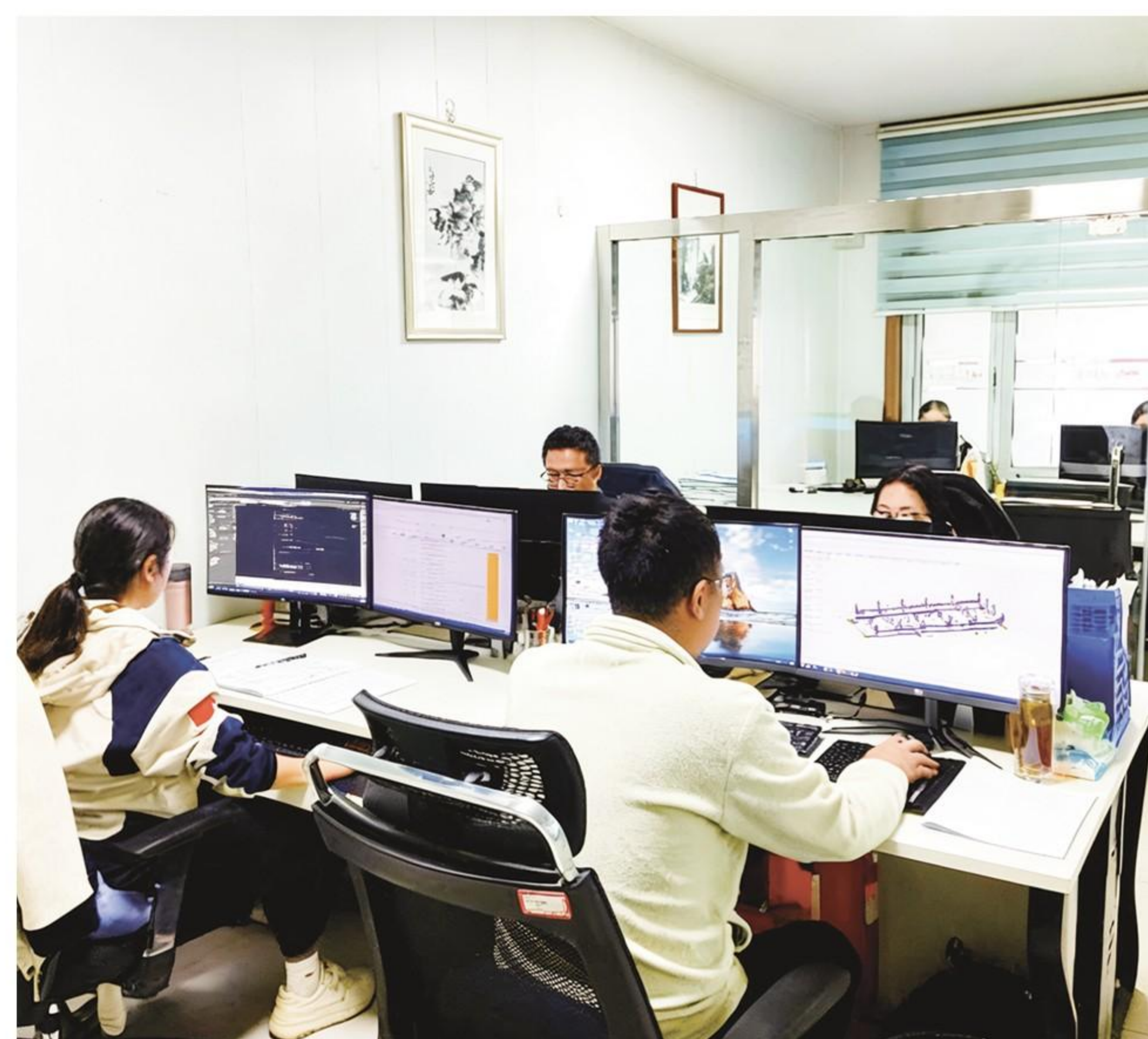
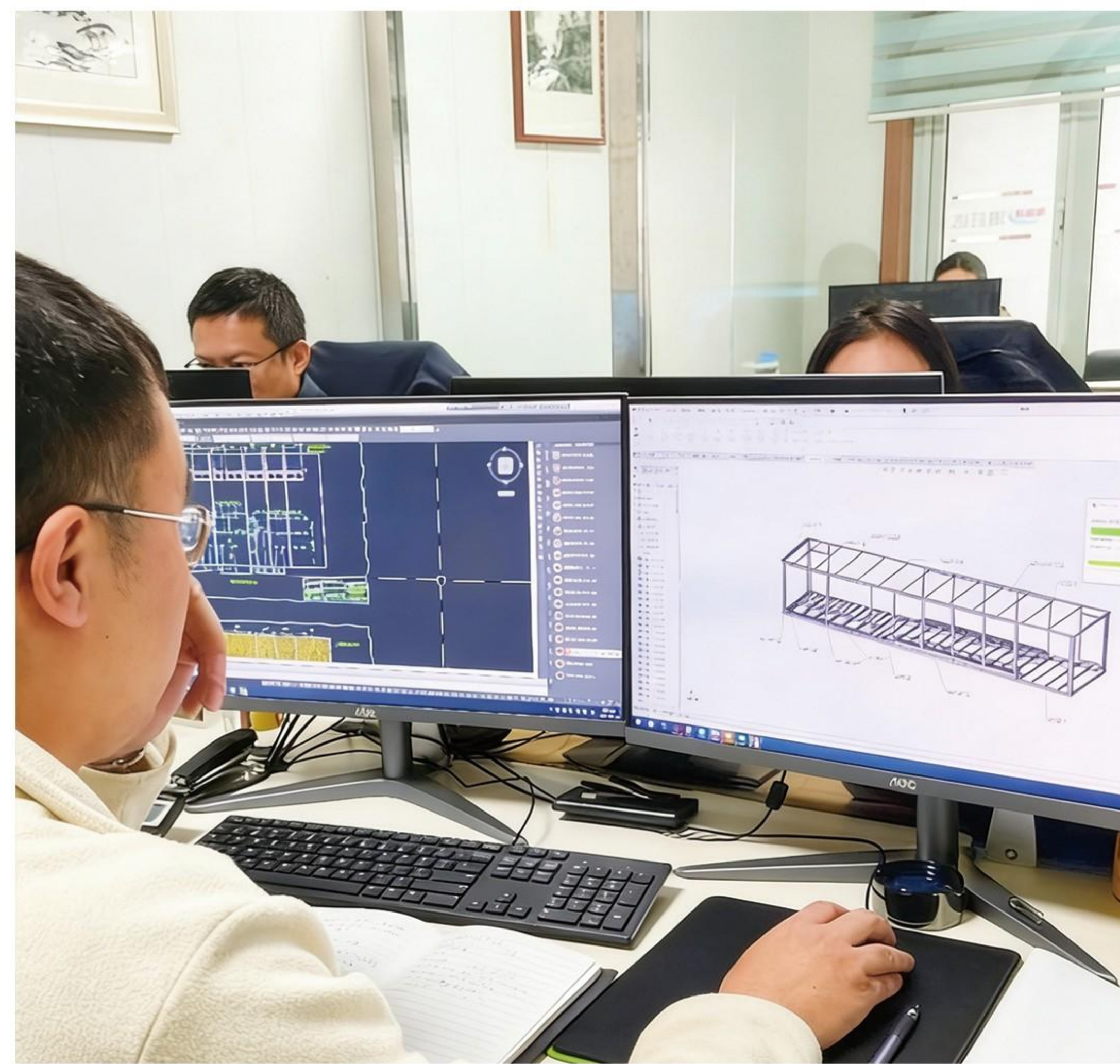

企业技术队伍实力雄厚，专业配置完善，现有结构工程师10余人、电气工程师2人，所有工程师均拥有5年以上集装箱设计从业经验，具备丰富的行业实践能力与专业技术储备。其中，高级工程师2人、中级工程师8人，团队专业层级分明，技术功底扎实。

公司专门配备专业研发中心，依托资深技术团队，可全方位为客户提供集装箱结构设计、有限元分析等定制化技术服务，精准满足客户各类个性化设计需求，为产品品质与项目落地提供强有力的技术支撑。

The enterprise has a strong technical team and complete professional configuration. There are currently more than 10 structural engineers and 2 electrical engineers, all of whom have more than 5 years of experience in container design and have rich industry practical abilities and professional technical reserves. Among them, there are 2 senior engineers and 8 intermediate engineers, with a clear professional hierarchy and solid technical foundation in the team.

The company is equipped with a professional R&D center and relies on a senior technical team to provide customers with customized technical services such as container structure design and finite element analysis in all aspects, accurately meeting various personalized design needs of customers and providing strong technical support for product quality and project implementation.

# Technical Support 技术支持

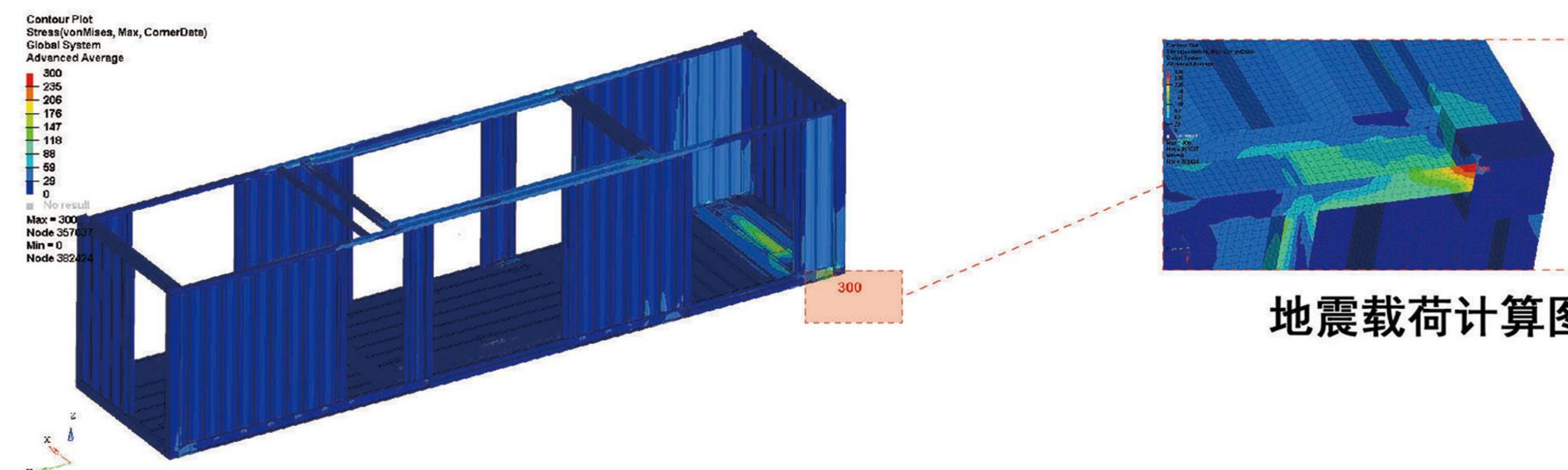

地震载荷计算图

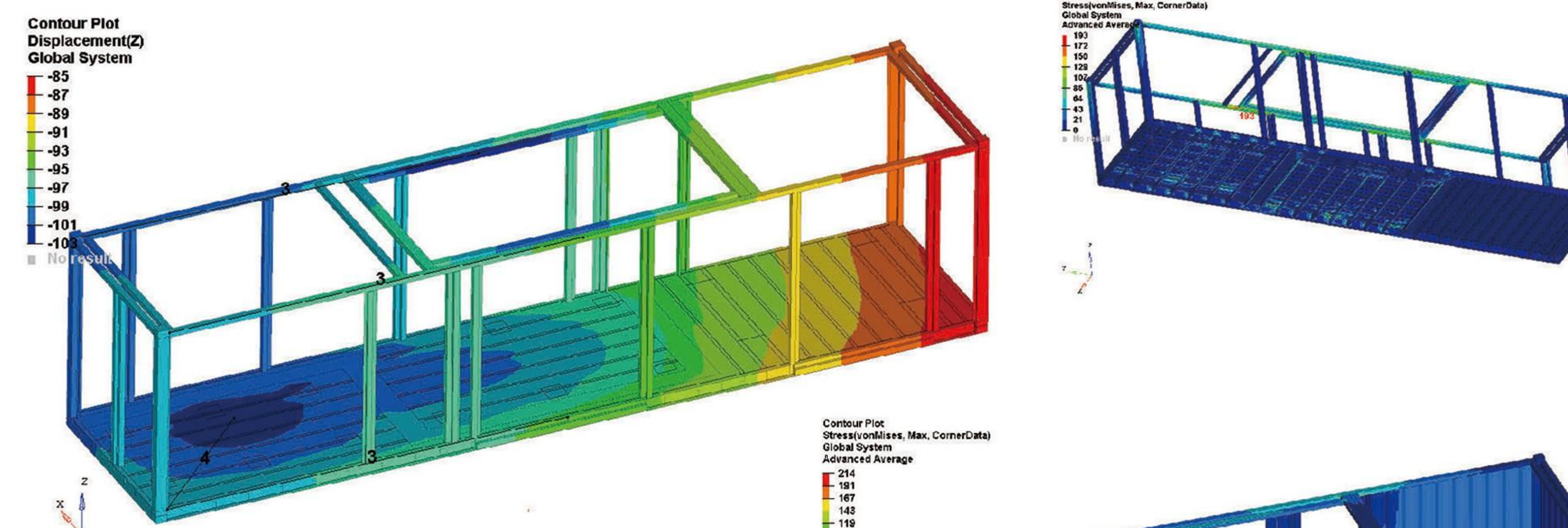

集装箱变形云图

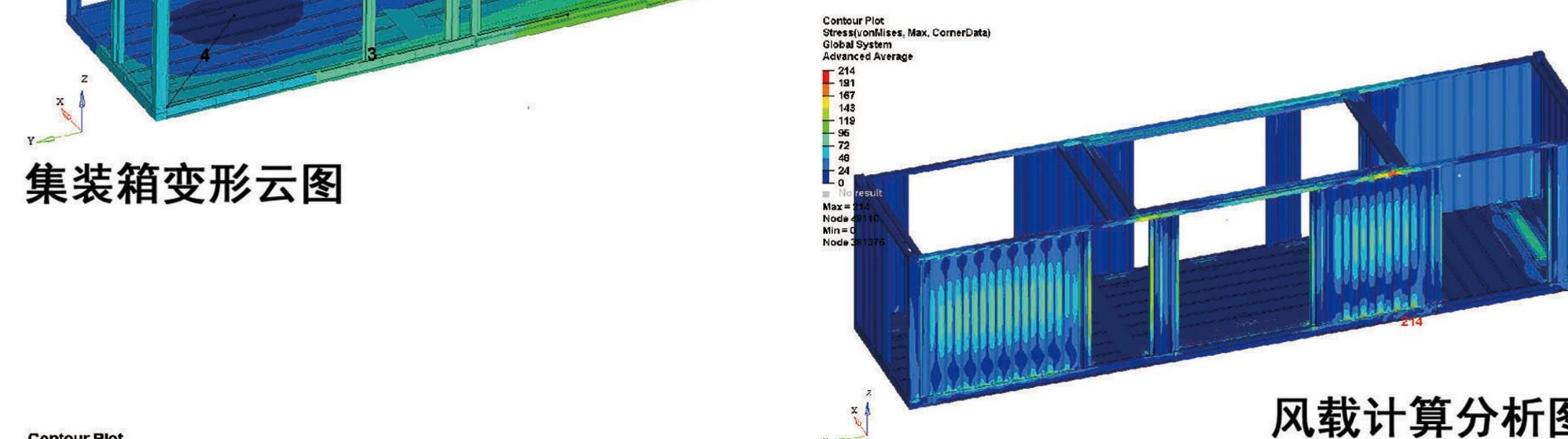

风载计算分析图

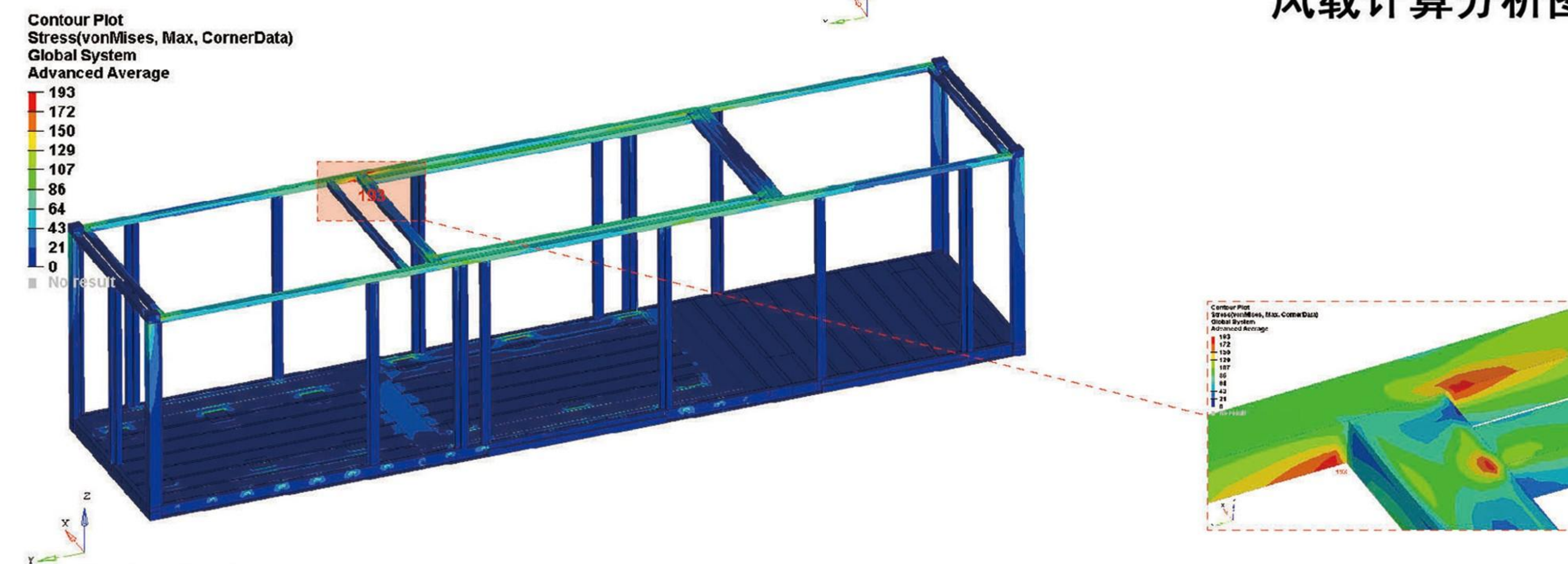

集装箱等效应力分

## Environmental Protection Container 环保箱

### 产品描述

环保集装箱以“全生命周期低碳、资源循环利用、高效适配多元场景”为核心定位，打破传统集装箱“高能耗、难回收、污染重”的痛点，融合绿色材料创新、清洁制造工艺与智能运维技术，覆盖物流运输、模块化建筑、新能源储能、环保处理等多领域，既是践行“双碳”目标的绿色载体，也是兼顾实用性与可持续性的新型环保装备，适配企业ESG披露与绿色采购需求，彰显低碳发展理念。



## 广西稀土氨氮废水处理设备



## SCSR高效生物膜反应污水处理站



## Military container 军用箱

### 产品描述

军用特种集装箱符合国军标（GJB）/ 军用规范，抗振动、抗跌落、抗盐雾、阻燃，涂装为军用哑光防腐涂层，低可视度、耐候耐磨，堆叠强度高，可多层堆叠储运，提升仓储与投送效率，通用性强与军用后勤体系、装卸机具、运输平台完全适配，可拓展为野战指挥所、医疗方舱、器材库、弹药箱、设备方舱等功能单元。高可靠性、长寿命、可重复使用，适应全域战场环境。



## 军用集装箱的优势

- 1、遵循国际标准实现多式联运，依托多元运力完成全域快速战略投送；
- 2、材质坚固抗损耐造，适配各类复杂地域，全天候全环境稳定可靠；
- 3、功能多元用途广泛，模块化组合搭建，随用随装快速投入使用；
- 4、外形低调易于隐蔽伪装，可悄然部署，有效提升作战战术突然性；
- 5、大幅缩减人力物力成本，提升保障效率，革新现代后勤保障模式；
- 6、规格品类齐全适配各类场景，可自由拼接组合，灵活实现规模弹性拓展。



## Explosion-proof container 防爆箱

### 产品描述

防爆箱集多种防爆电气设备于一体，内部配有通风排气系统、温湿度控制系统、防爆配电系统、防爆照明系统、气体探测系统等，箱体尺寸及各系统的电气数量根据用户实际使用情况配置，可增减。



# Offshore container 近海箱

试验项目	箱内载荷	试验方法
两点起吊	1.5R-T	通过2只吊耳对角起吊
四点起吊	2.5R-T	通过4只吊耳起吊
垂直冲击试验 (跌落试验)	P	当箱体最薄弱点离开地面50mm时，使其跌落到水泥地面或硬结构表面上
叉举	1.6(R+S)-T	通过叉杆伸入叉槽举起，叉杆长度为叉槽长度的3/4
倾斜试验	P	箱体往任意方向倾斜30° 都不倾覆

## 两点吊工况

约束起吊点，在箱底添加弱弹簧，辅助限制箱体以免发生刚体运动。箱内添加1.5P载重（均匀分布），在垂直向下方向添加1.5g惯性加速度，使模型最终产生向下1.5Rg的惯性力。

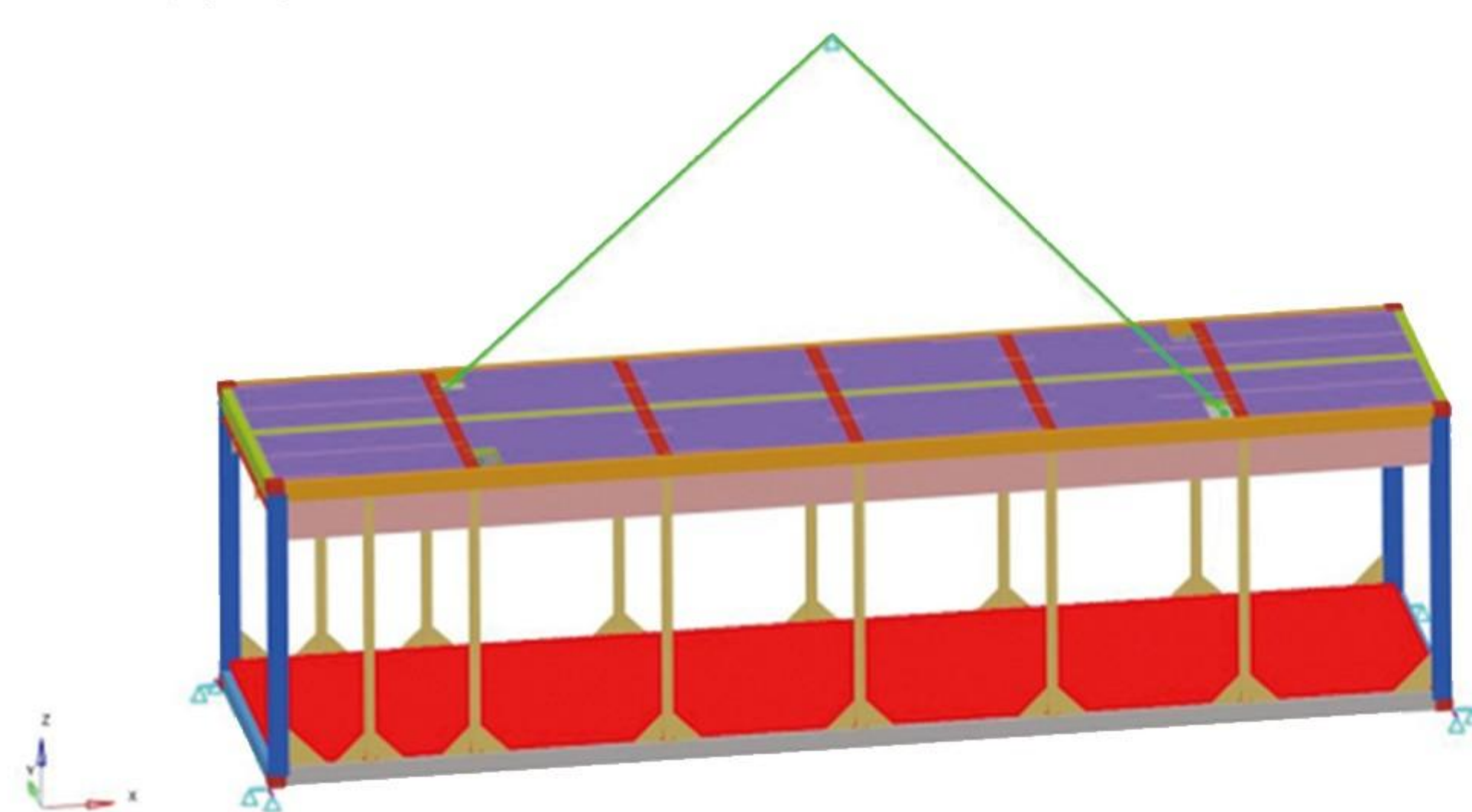

两点吊边界条件

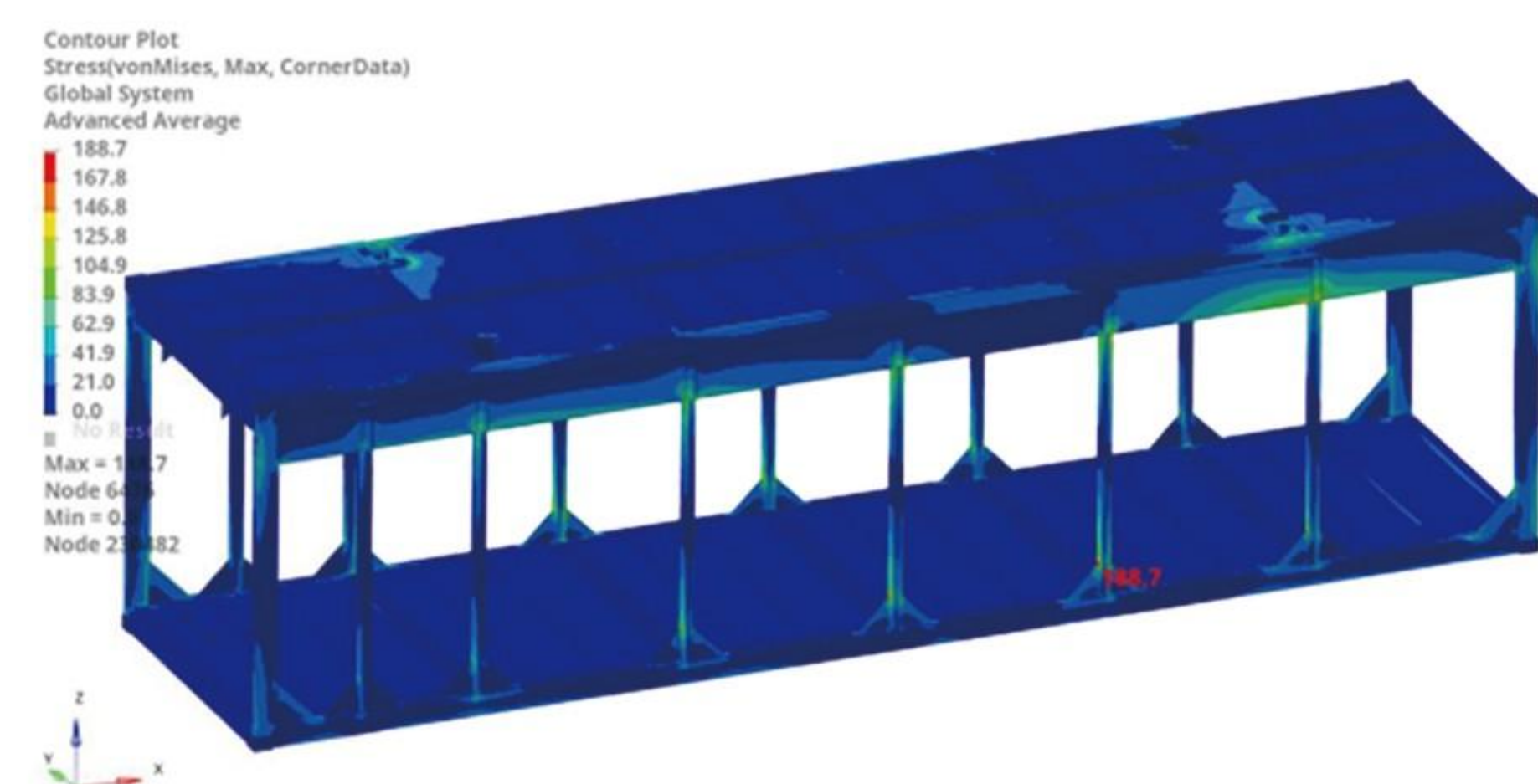

两点吊等效应力云图

## 垂直冲击工况

约束顶角件，在底端梁、底侧梁中间分别添加大小为0.25R的集中力。



垂直冲击等效应力云图

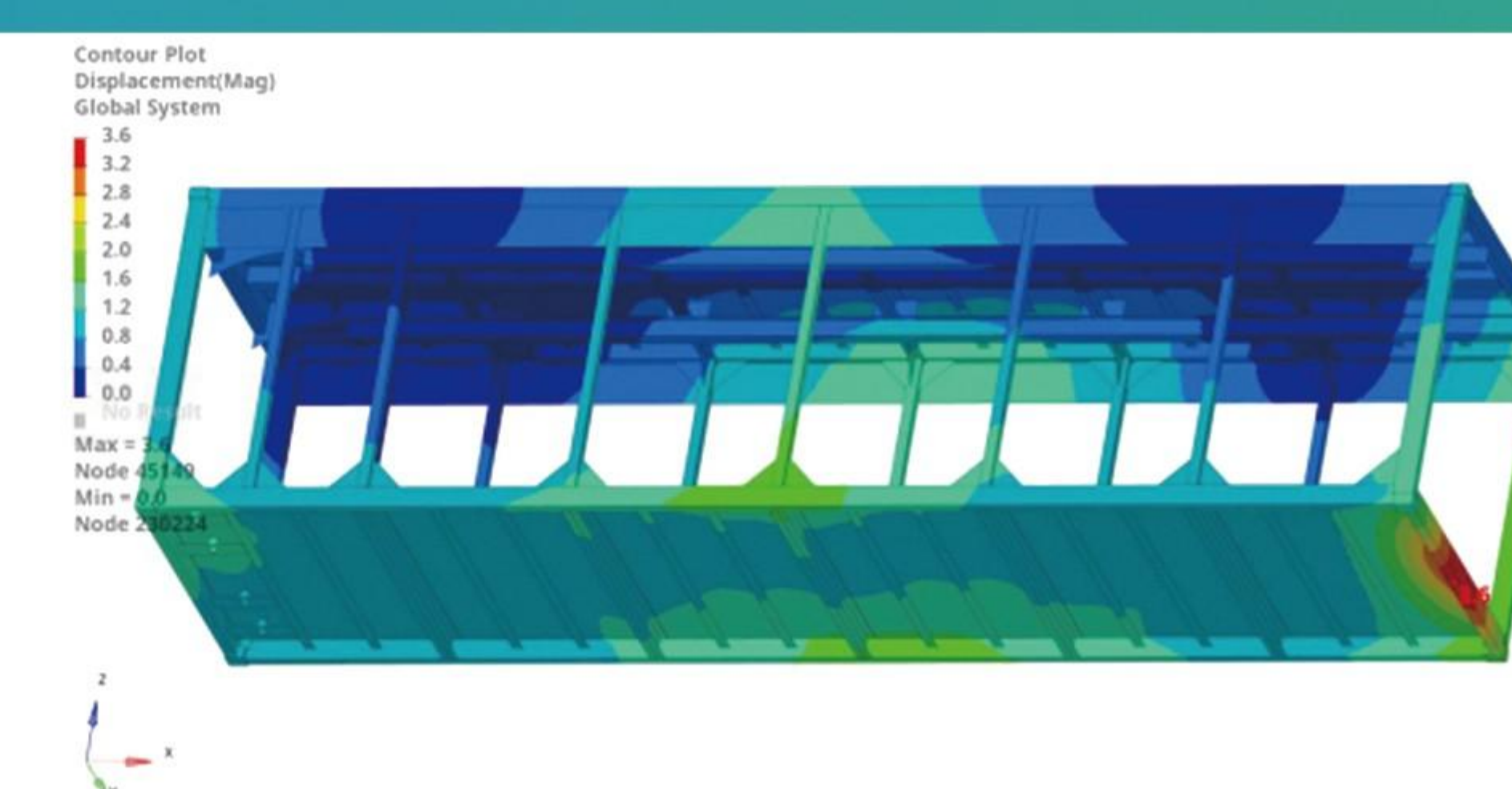

垂直冲击变形云图

## 四点吊工况

约束起吊点，在箱底添加弱弹簧，辅助限制箱体以免发生刚体运动。箱内添加2.5P载重（均匀分布），在垂直向下方向添加2.5g惯性加速度，使模型最终产生向下2.5Rg的惯性力。

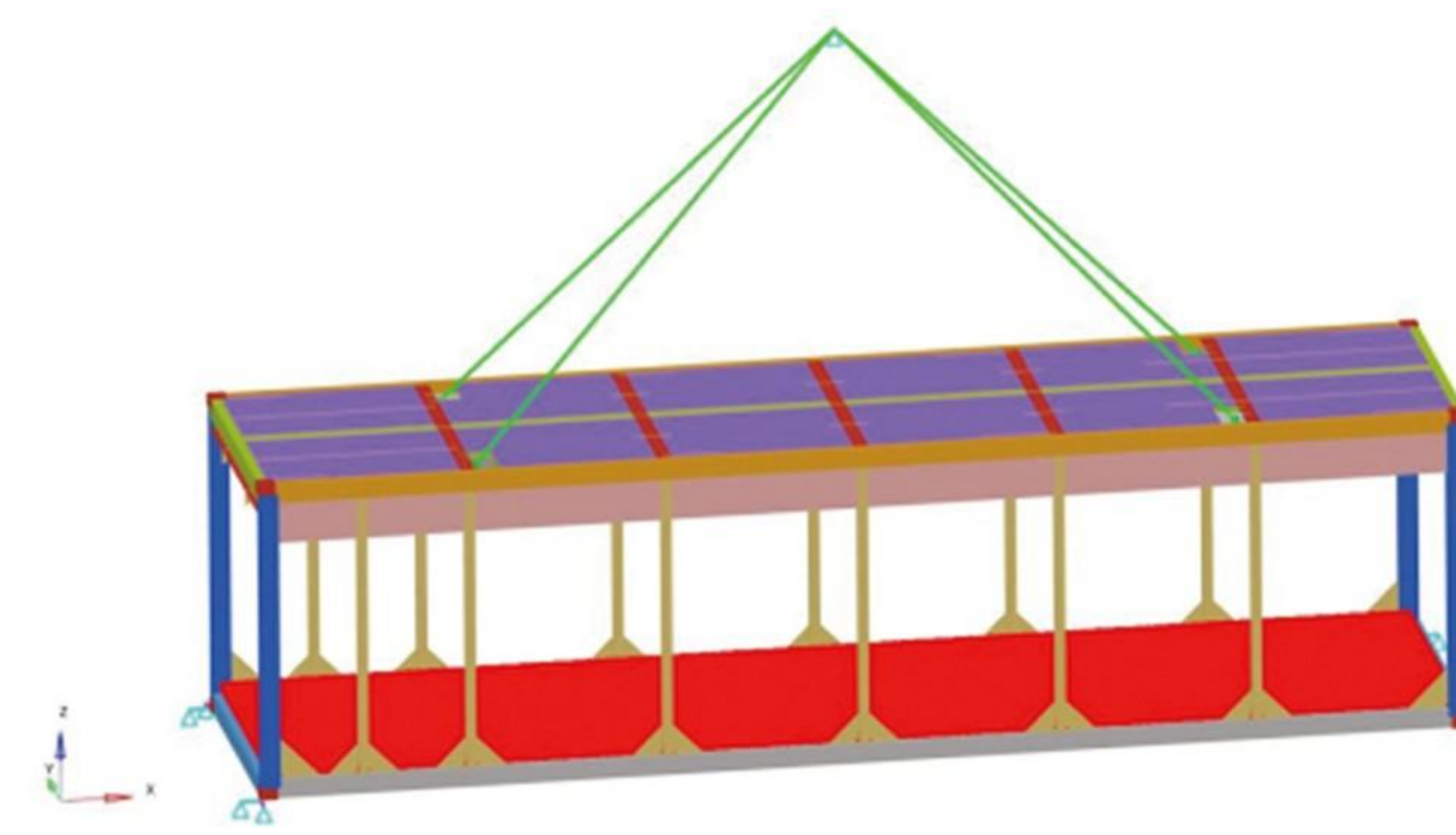

四点吊等效应力云图

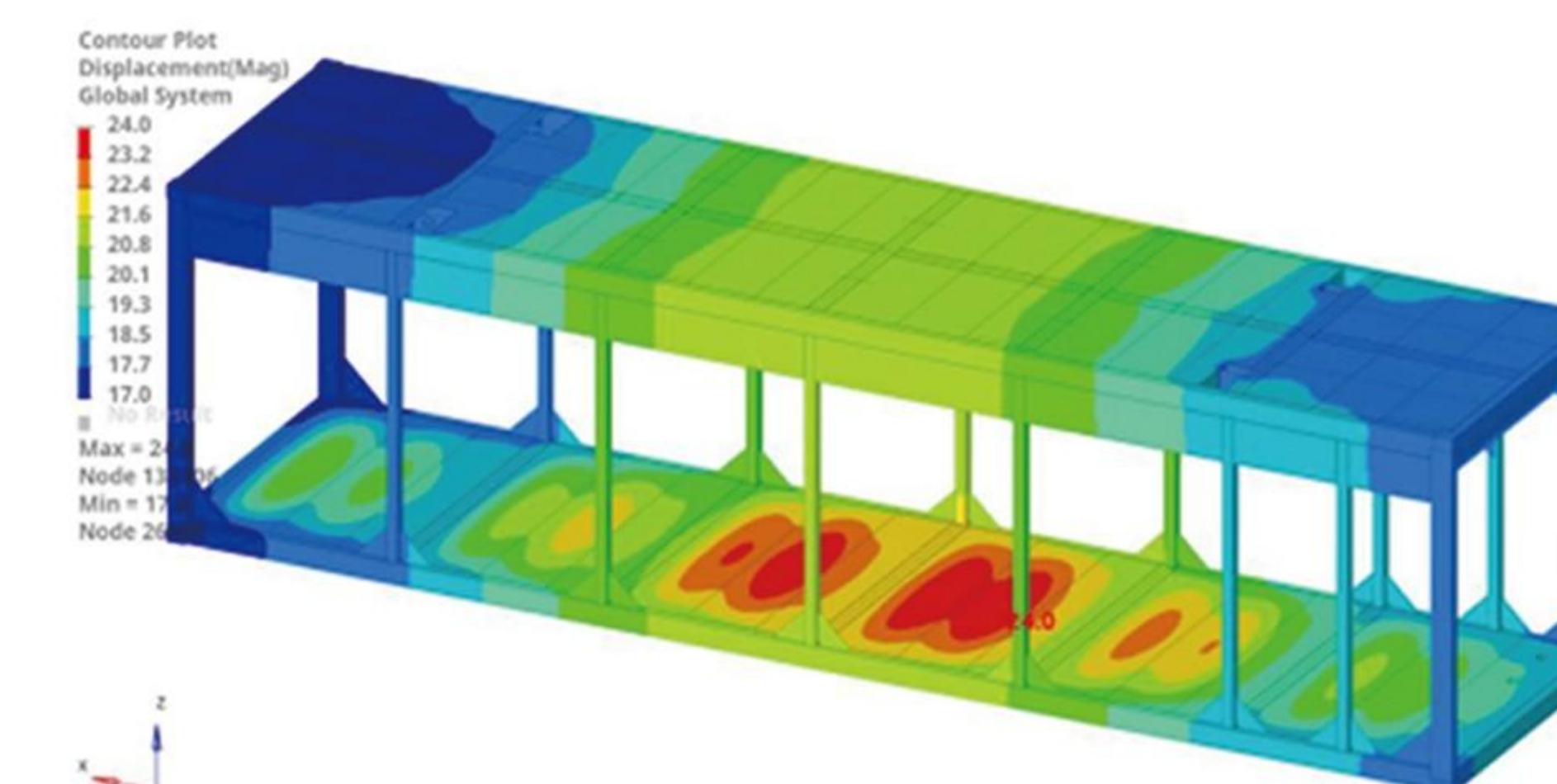

四点吊整体变形云图

## Case Showcase 案例展示

### 产品优势

近海集装箱是海上物流与工程的核心装备,以强结构、高防腐、安全吊装、模块化为核心优势,适配严苛海洋环境,长期综合成本更低,广泛应用于海上风电、油气平台、海岛建设等领域。



## Tool container 工具箱

### 产品描述

工具箱具有集装箱外形结构，根据用户使用需求而设计制作，通过增加开门、保温、照明、空调、货架、桌椅等设施满足各行业集成运输和使用，产品具有可移动，可重复使用，结构多样化，绿色环保，无建筑垃圾等特点。

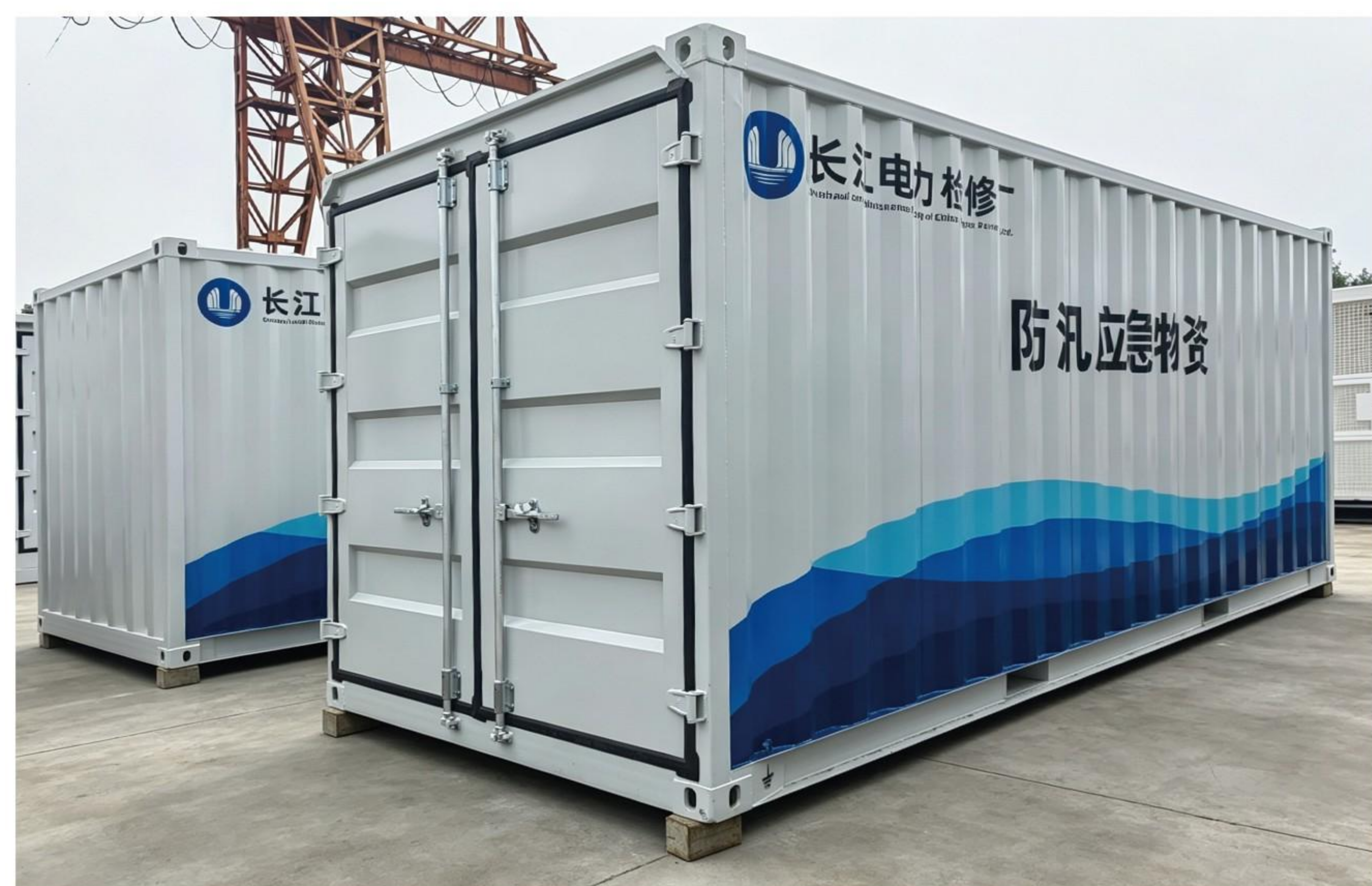

## Thermal energy container 热能箱

### 产品描述

热能集装箱（又称蓄热集装箱、移动热能站、集装箱式换热站），是以标准集装箱为载体，集成热源（电热 / 燃气 / 生物质 / 余热）、储能单元（相变材料 PCM / 熔盐）、换热设备、保温结构、智能控制系统的一体化热能解决方案，可实现热能的生产、储存、输送与温控管理。



## Container Gas Station 集装箱式加气站

### 产品描述

一体式撬装加气集装箱，依托标准集装箱壳体集成成套加气设备，集气体储存、调压、计量、加注、安全防护、智能管控于一体，模块化预制组装，结构紧凑坚固，运输便捷、落地即用，是移动式、分布式加气建站优选装备。

### 中国石化LNG加气站



### 高速LNG加气站



### LNG加气站



### CNG加气集装箱



## Container modular fire station 集装箱模块化消防站

### 产品描述

集装箱模块化消防站，是基于标准集装箱单元、工厂预制、现场快速拼装的可移动、可扩展、智能化消防救援设施，专为快速补位城市消防盲区、老旧城区、产业园区、港口码头、重点厂区及临时应急布防设计，标准化模块：含消防车库、器材储备室、通讯指挥室、消防员备勤室、盥洗卫浴、多功能训练区等独立单元，可按需组合、分层堆叠，灵活适配单车位 / 多车位、单层 / 双层布局。可移动复用：整体可拆卸、吊装转运，适配临时驻地、灾后重建、场地调整等场景，重复利用率高，大幅降低综合成本。



## 武汉东西湖区双车位消防站



## 邯郸街道三车位消防站



## Container accessories 集装箱配件

### 产品描述

集装箱角件、集装箱锁具、集装箱侧板、集装箱门铰链、集装箱密封胶条等全套集装箱配件:全部配件采用工业耐用材质,防腐防锈、抗压承重强,尺寸精准贴合标准箱体,防水密封性能优异,适配海运、模块化箱房、工程特种集装箱各类场景,品质稳定,安装便捷。



集装箱铰链



折叠插销

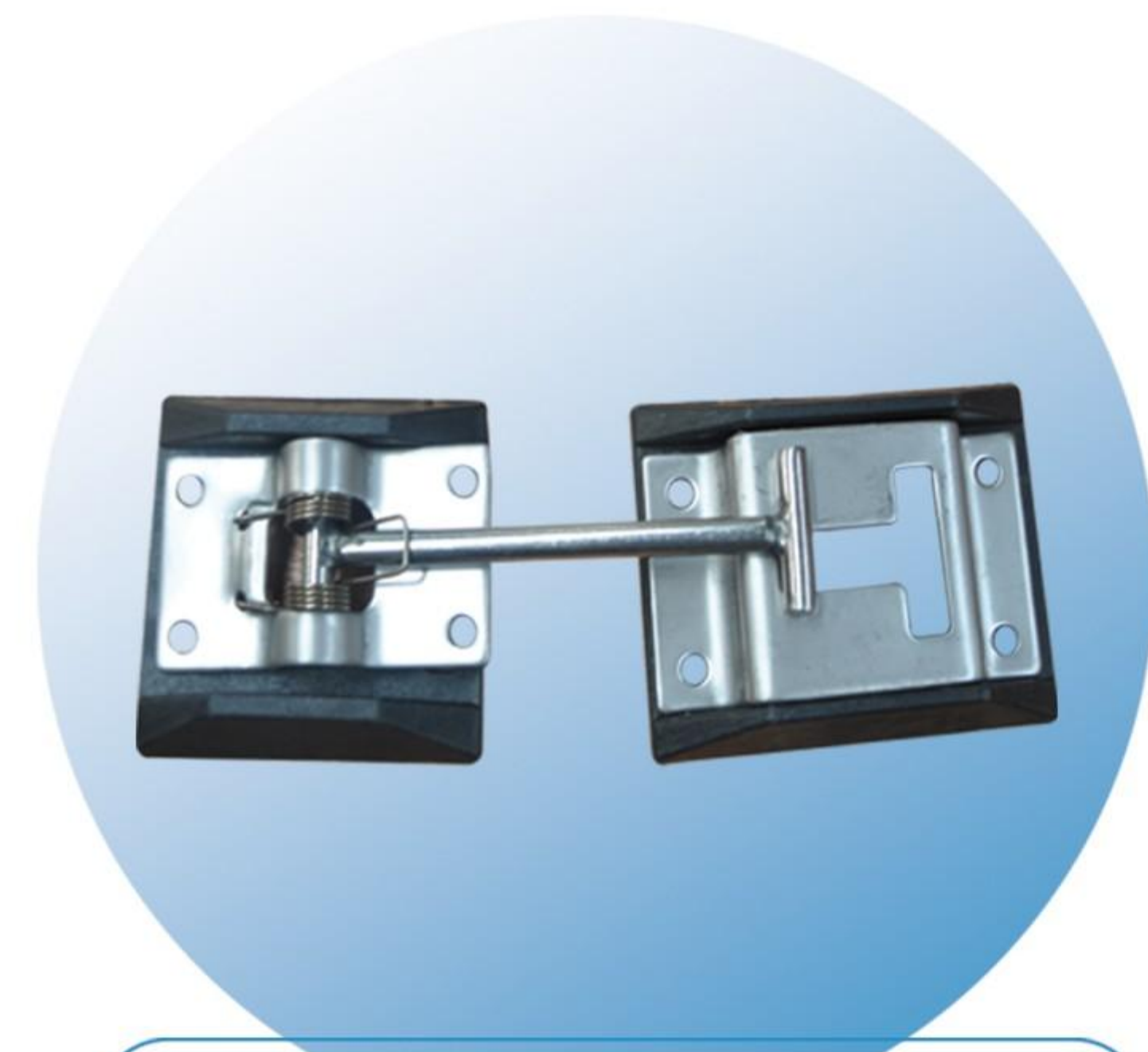

集装箱风钩

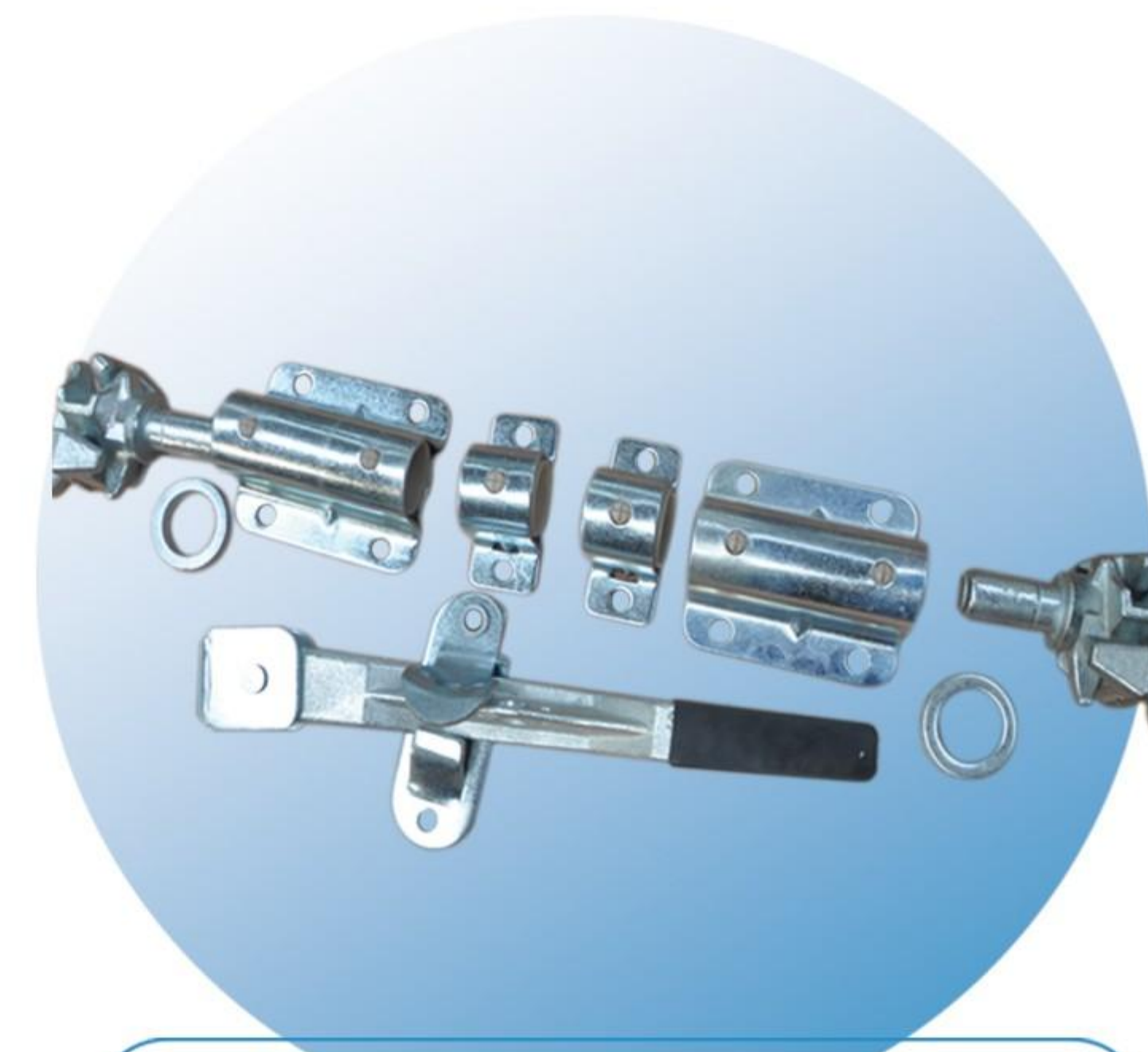

集装箱锁具

配件名称	常用材质	执行标准
集装箱角件	SCW490 铸钢、ZG270-500	ISO 1161、GB/T 1835-2023
集装箱锁具	45# 钢、40Cr、Q345B, 热镀锌处理	ISO 17712、GB/T 11577-2020
集装箱侧板	SPA-H 耐候钢、Q345GNHL、镀锌钢板	ISO 1496-1、GB/T 32570-2016
集装箱门铰链	Q345B 耐候钢、304 不锈钢锻打	ISO 1496-1、行业通用标准
集装箱密封胶条	EPDM 三元乙丙橡胶	GB/T 15846-2006、JT/T 811



车厢铰链

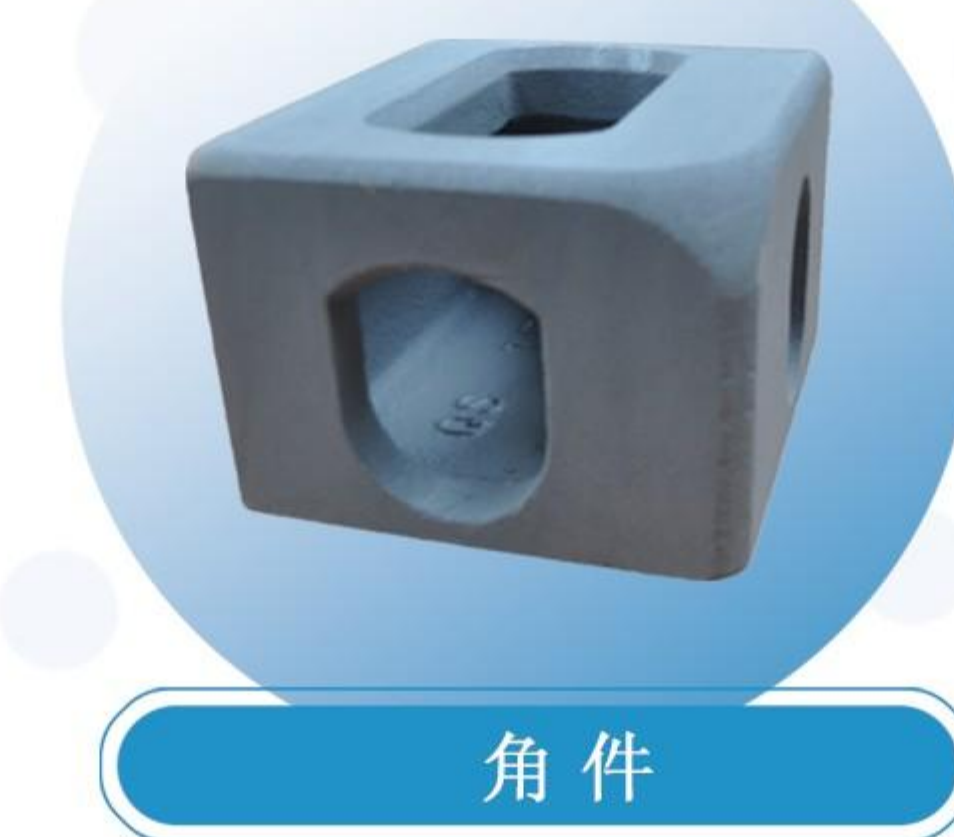

角件



360搭扣锁



全胶胶条

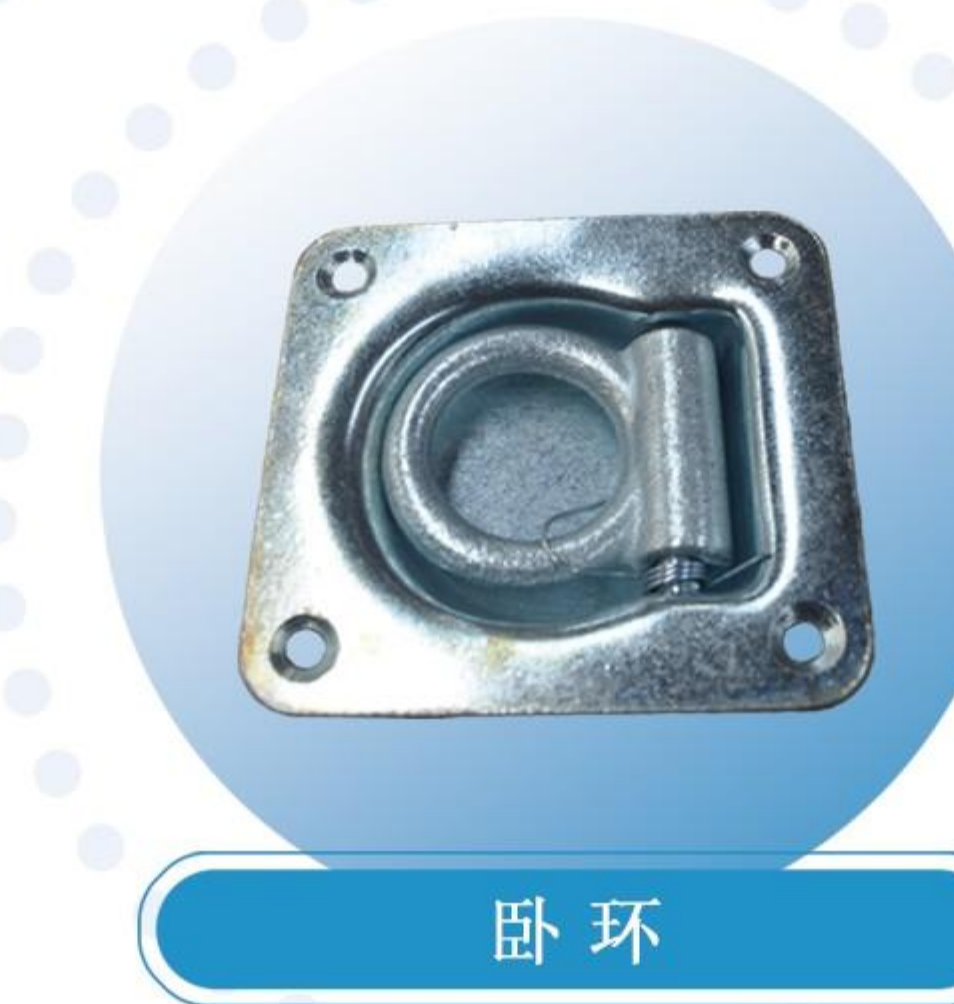

卧环

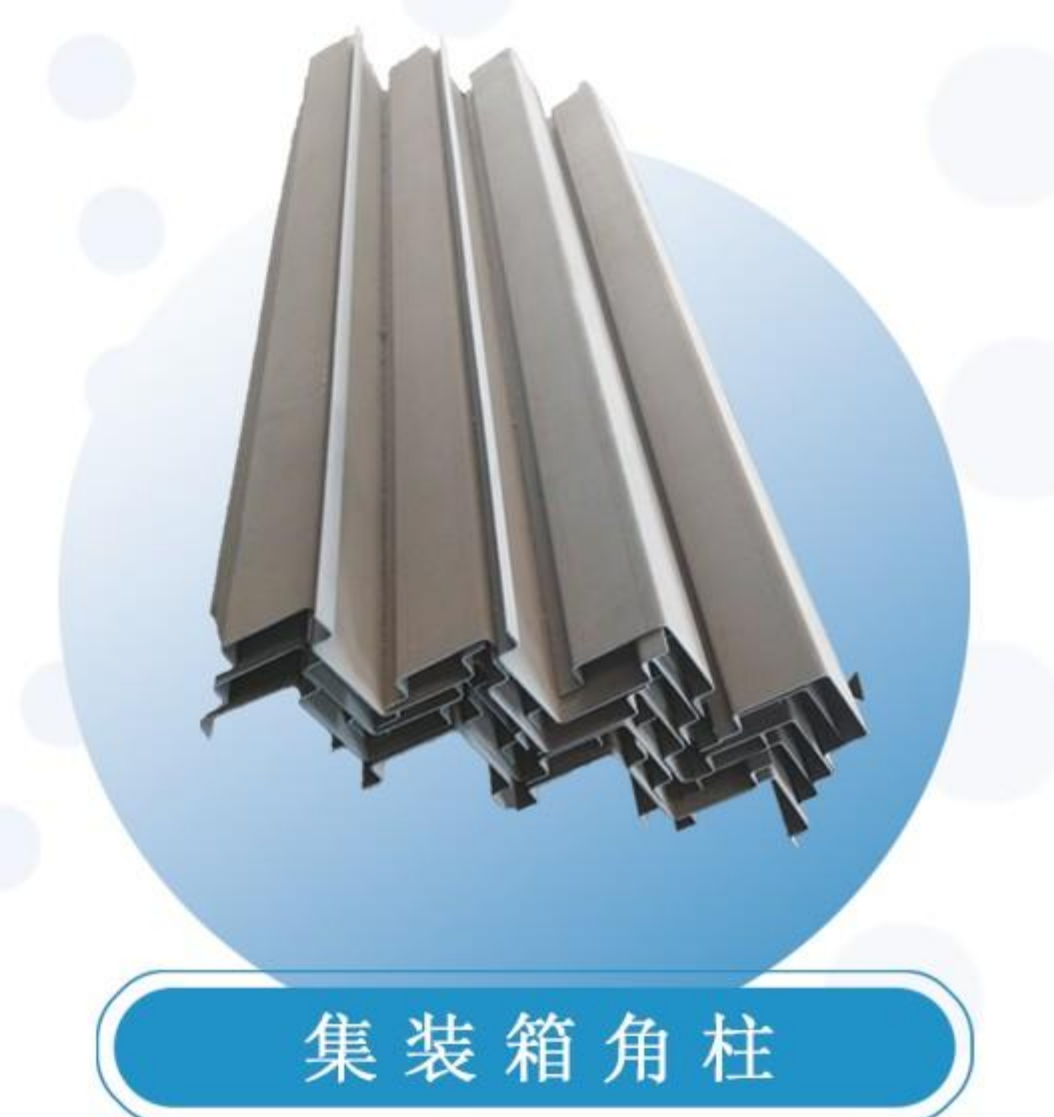

集装箱角柱



折叠爬梯

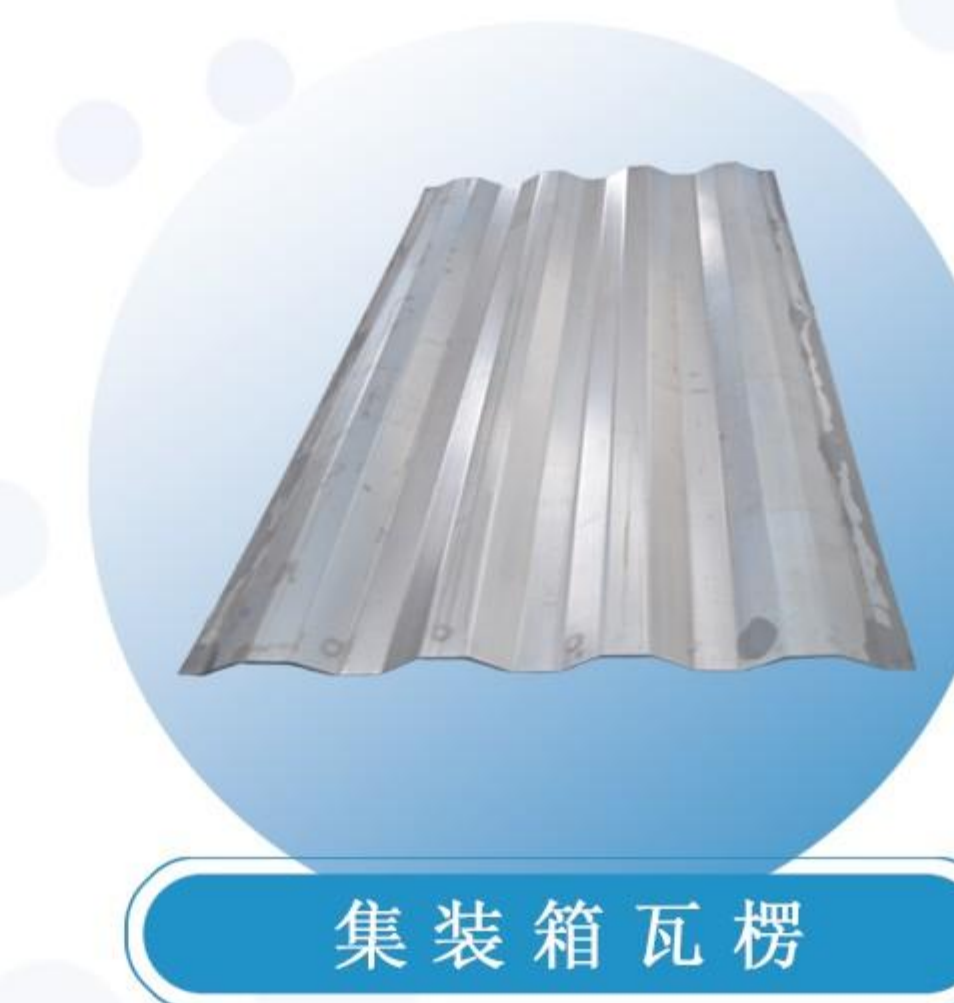

集装箱瓦楞

Cooperation partners  
| 合作伙伴

